

High Productivity Cooking Electric Tilting Braising Pan, 24gal (90lt), Hygienic Profile, Freestanding with CTS

ITEM # _____

MODEL # _____

NAME # _____

SIS # _____

AIA # _____



587031 (PFET09ECUU)

EL. TILT.BRAIS.
 PAN,90L/24GAL,208V,FS,
 USA

Short Form Specification

Item No. _____

Motorized tilting with variable speed control. Pan can be tilted beyond 90° to completely empty the food. The electric heating elements are mounted under the well. Safety thermostat protects the pan from overheating. A precise, electronic control of pan bottom temperature ensures fast reaction and exact adherence to pre-selected cooking temperatures between 122°F (50°C) and 480°F (250°C). Automatic steam elimination at the end of the cooking cycle. It can be used for poaching or steaming (with the lid open); simmering and boiling (with open or closed lid). TOUCH control panel. SOFT function. PRESSURE function. Possibility to store recipes in single or multiphase cooking process, with different temperature settings. Built in temperature sensors for precise control of cooking process. Core Temperature Sensor provides efficient temperature control. IPX6 water resistant.

Main Features

- Pan size is GN compliant.
- Easy to clean cooking surface due to large-radius edges and corners.
- Thermoblock heating system for optimal temperature distribution and high temperature stability.
- Pan bottom with two individually adjustable heating zones, each with a temperature sensor.
- IPX6 water resistant.
- Temperature sensors provides efficient temperature control: the power is supplied as and when required to keep the set temperature value without exceeding it.
- Optimum heat distribution in the food provides best cooking results in terms of taste, color and consistency and in terms of vitamin preserving.
- Motorized, variable pan tilting with "SOFT STOP". Tilting and pouring speeds can be precisely adjusted. Pan can be tilted over 90° to facilitate pouring and cleaning operations.
- Built in temperature sensor to precisely control the cooking process.
- No overshooting of cooking temperatures, fast reaction.
- USB connection to easily update the software, upload/download recipes and download HACCP data.
- Multifunctional cooking appliance used for roasting, pot-roasting, braising, simmering, boiling and steaming.

Construction

- External panelling and internal frame made of 1.4301 (AISI 304) stainless steel.
- Multipurpose non-stick cooking surface in 0.75" (18 mm) thick compound: 0.1" (3 mm) shot-blasted 1.4404 (AISI 316L) stainless steel surface, seamlessly welded to the mild steel bottom.
- Double-lined insulated lid in 1.4301 (AISI 304) stainless steel mounted on the cross beam of the unit, counterbalanced by a hinge that remains open in all positions.
- 0.6" (15 mm) thick heating layer concealed below the entire pan bottom, to provide high thermal diffusion and heat storage properties.
- Water mixing tap is available as optional accessory to make water filling and pan cleaning easier.
- Heatproof handle with non-slip surface.
- Front-mounted inclined led "TOUCH" control panel with recessed deep drawn casing, features self-explanatory functions which guide operator

APPROVAL: _____

throughout the cooking process: simultaneous display of actual and set temperature as well as set cooking time and remaining cooking time; real time clock; "SOFT" control for gentle heating up for delicate food; 9 power simmering levels from gentle to heavy boiling; timer for deferred start; error display for quick troubleshooting.

- Possibility to store recipes in single or multiphase cooking process, with different temperature settings.
- Minimised presence of narrow gaps for easier cleaning of the sides to meet the highest hygiene standards.
- Can be prearranged for energy optimisation or external surveillance systems (optional).
- 98% recyclable by weight; packaging material free of toxic substances.
- [NOT TRANSLATED]
- [NOT TRANSLATED]
- [NOT TRANSLATED]

User Interface & Data Management

- Connectivity ready for real time access to connected appliances from remote and data monitoring (requires optional accessory - contact the Company for more details).

Sustainability



- High-quality thermal insulation of the pan saves energy and keeps operating ambient temperature low.

Optional Accessories

- Dumpling strainer for 21/26 gallon kettles PNC 910053
- Scraper for "dumpling" strainer for kettles PNC 910058
- Perforated container with handles, height 4" (102mm) PNC 910211
- Perforated container with handles, height 6" (152mm) PNC 910212
- Perforated container with handles, height 8" (203mm) PNC 911673
- Left cover plate and mixing faucet for kettle (587040), and all braising pans (587037, 587039, 587031, 587035, 587027, 587028, 587021, and 587025) PNC 911819
- Suspension frame for Non-Pressurized Tilting Braising Pans - 2 needed for 24 gallon units (587031, 587037) - 3 needed for 45 gallon units (587035, 587039) PNC 912709
- Spray gun for tilting units, height 27-1/2" (698.5mm) - factory fitted PNC 912776
- SCRAPER WITHOUT HANDLE (PFEX/PUEX) PNC 913431
- - NOT TRANSLATED - PNC 913432
- 4 flanged feet, 2", for prothermetic units (kettles, braising pans & pressure braising pans) PNC 913438

- - NOT TRANSLATED - PNC 913577
- Spray gun kit for free-standing ProThermetic Tilting units H=700 - US - Field Mounted PNC 913579

Front

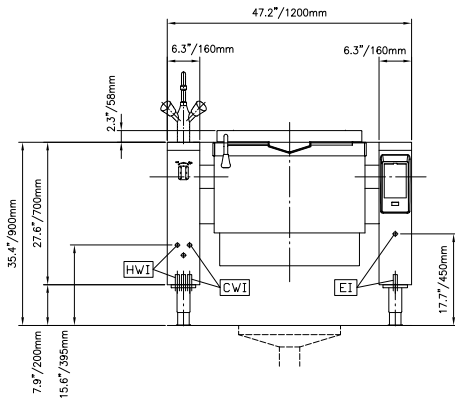

Side

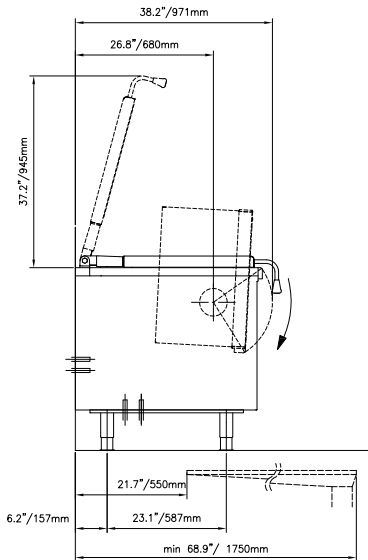

CWII = Cold Water inlet

EI = Electrical connection

HWI = Hot water inlet

Top

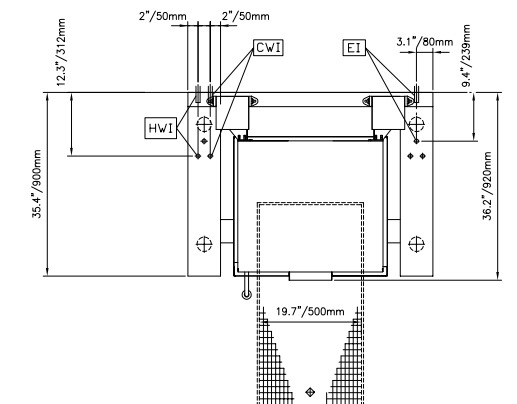

Electric

Supply voltage:

587031 (PFET09ECUU) 208 V/3 ph/60 Hz

Total Watts:

15.5 kW

Total Amps

43 A

Water:

Incoming Cold/hot Water
 line size:

1/2"

Installation:

FS on concrete base;FS on
 feet;On base;Standing
 against wall

Type of installation:

Key Information:

Configuration: Rectangular;Tilting

Working Temperature MIN: 122 °F (50 °C)

Working Temperature MAX: 482 °F (250 °C)

External dimensions, Width: 47 1/4" (1200 mm)

External dimensions, Depth: 35 7/16" (900 mm)

External dimensions, Height: 27 9/16" (700 mm)

Net weight: 529 lbs (240 kg)

Shipping width: 47 1/4" (1200 mm)

Shipping depth: 51 3/16" (1300 mm)

Shipping height: 39 3/8" (1000 mm)

Shipping weight: 661 lbs (300 kg)

Shipping volume: 55.08 ft³ (1.56 m³)

Tilting mechanism: Automatic

Double jacketed lid: ✓

Heating type: Direct



**High Productivity Cooking
Electric Tilting Braising Pan, 24gal (90lt),
Hygienic Profile, Freestanding with CTS**



**High Productivity Cooking
Electric Tilting Braising Pan, 24gal (90lt), Hygienic Profile, Freestanding
with CTS**
The company reserves the right to make modifications to the products
without prior notice. All information correct at time of printing.

2024.09.16